



*The installer's choice*

# Product Selector

2014 Edition



[www.cdvi.co.uk](http://www.cdvi.co.uk)

CONTENTS	PAGE No.
STANDALONE KEYPADS	P. 4
STANDALONE ACCESS CONTROL	P. 6
ONLINE ACCESS CONTROL	P. 8
READERS, CARDS & TAGS	P. 14
ELECTROMAGNETIC LOCKING DEVICES	P. 18
ELECTRIC LOCKING & STRIKES	P. 32
EXIT BUTTONS, DEVICES, TIMERS ETC	P. 38
POWER SUPPLIES	P. 45
DOOR AUTOMATION	P. 46
WIRELESS CONTROLS	P. 48
INTERCOM POSTS	P. 52
GENERAL INFORMATION	P. 53

**KEYPADS**
**PROMI ECO**

Self-contained

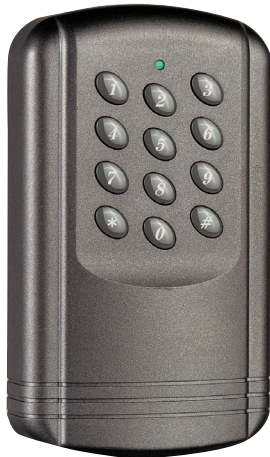

- *Compact, affordable*
- *Sturdy polycarbonate*
- *100 user codes*
- *Timed relay output*
- *Exit button input*
- *Simple surface mount*

- *12V ac/dc*
- *100mA max*
- *145 x 80 x 28mm*

Self-contained

**DGA**

- *Backlit for convenience*
- *Vandal resistant*
- *100 user codes*
- *2 timed/latching relays*
- *Secure surface mount*

- *12-48Vdc/12-24Vac*
- *100mA max*
- *120 x 98 x 25mm*

**GALEO**

Remote electronics (included)



- *Backlit for convenience*
- *Stylish & vandal resistant*
- *Remote electronics for added security*
- *100 user codes*
- *2 or 3 timed/latching relays*
- *Secure surface mount*

- *12-48Vdc/12-24Vac*
- *100mA max*
- *110 x 75 x 15mm*



## KEYPADS

## PROFIL100E

Self-contained or Remote electronics



- Backlit for convenience
- Narrow style to suit restrictive frame sizes
- Vandal resistant
- 100 user codes
- 2 timed/latching relays
- Remote electronics (optional for added security)
- Secure surface mount

- 12-48Vdc/12-24Vac
- 100mA max
- 165 x 43 x 27mm

Optional

Self-contained

## CBB &amp; CAASE

- High grade stainless steel
- Vandal resistant
- 100 user codes
- 4, 5 or 6 digit codes
- 3 timed/latching relays
- Braille keys
- Secure surface mount

- 12-48V dc
- 12-24V ac
- 120mA max
- 120 x 100 x 65mm



CBB

## CAASE



- High grade stainless steel
- Backlit
- Vandal resistant
- 100 user codes
- 3 timed/latching relays
- Secure flush mount

- 12-48Vdc/12-24Vac
- 140mA max
- 125 x 100 x 3mm



**STANDALONE ACCESS CONTROL**
**DIGITAG LR**

Long range reader/controller



- *Self contained reader*
- *30 users*
- *Hands free operation*
- *Up to 15 metres range*
- *Timed relay output*
- *Exit button input*
- *Audible & visual signal*
- *Uses DTXT range of cards*

- 12-30Vdc
- 40mA
- 90 x 60 x 22mm

Single door reader/controller

**PROMI 500/1000PC**

- *Compact proximity reader/controller*
- *Sturdy polycarbonate*
- *Option of 500 or 1000 users*
- *Timed/latching relay output*
- *Exit button input*
- *Remote read-head option*
- *Software & reports (PROMI1000PC)*

- 12V ac/dc
- 300mA
- 145 x 80 x 28mm



STANDALONE ACCESS CONTROL

DG502

2-door controller











- 2-door controller
- Assign users to door 1, door 2 or both
- 500 user capacity
- 2 timed/latching relay outputs
- 2 exit button inputs
- Connects to CDVI readers (see below)

- 12V ac/dc
- 200mA
- 116 x 116 x 23mm

Proximity & hands free

Readers & Cards

 <p><b>Polycarbonate proximity reader</b> Internal or external use 103 x 81 x 23mm</p>	 <p><b>Polycarbonate proximity reader</b> Internal or external use 139 x 41 x 23mm</p>															
 <p><b>Stainless steel proximity reader</b> Internal or external use 97 x 76 x 20mm</p>	 <p><b>Stainless steel proximity reader</b> Internal or external use 140 x 35 x 22mm</p>															
 <p><b>Polycarbonate panel reader</b> Internal or external use 44mmØ x 31height x 18mm</p>	 <p><b>Long range reader</b> Internal or external use 90 x 60 x 22mm</p>															
 <table border="1" data-bbox="264 1850 796 1921"> <thead> <tr> <th>Reference</th> <th>Description</th> <th></th> </tr> </thead> <tbody> <tr> <td>METAL1</td> <td>Robust prox fob, 10 pack</td> <td></td> </tr> </tbody> </table>	Reference	Description		METAL1	Robust prox fob, 10 pack		<table border="1" data-bbox="826 1816 1485 1921"> <thead> <tr> <th>Reference</th> <th>Description</th> <th></th> </tr> </thead> <tbody> <tr> <td>CPE</td> <td>Clamshell prox card, 10 pack</td> <td></td> </tr> <tr> <td>CPC</td> <td>ISO printable prox card, 25 pack</td> <td></td> </tr> </tbody> </table>	Reference	Description		CPE	Clamshell prox card, 10 pack		CPC	ISO printable prox card, 25 pack	
Reference	Description															
METAL1	Robust prox fob, 10 pack															
Reference	Description															
CPE	Clamshell prox card, 10 pack															
CPC	ISO printable prox card, 25 pack															
 <table border="1" data-bbox="264 1977 796 2049"> <thead> <tr> <th>Reference</th> <th>Description</th> <th></th> </tr> </thead> <tbody> <tr> <td>PPC</td> <td>Standard fob, 10 pack</td> <td></td> </tr> </tbody> </table>	Reference	Description		PPC	Standard fob, 10 pack		 <table border="1" data-bbox="956 1977 1485 2049"> <thead> <tr> <th>Reference</th> <th>Description</th> <th></th> </tr> </thead> <tbody> <tr> <td>DTXT5434</td> <td>Active card for use with DTRR1434R</td> <td></td> </tr> </tbody> </table>	Reference	Description		DTXT5434	Active card for use with DTRR1434R				
Reference	Description															
PPC	Standard fob, 10 pack															
Reference	Description															
DTXT5434	Active card for use with DTRR1434R															



Whether you prefer traditional hard-wiring, or are looking for a system which is fully IP, then **ATRIUM** is the product for you. In fact, you can “mix-n-match” with some **ATRIUM** controllers on a network, and some hard-wired. The system is so flexible and straightforward, that even new installers to access control will be able to confidently provide customers with a system that is user-friendly and reliable.

### Simplicity

*A simple and logical wiring structure, plug & play hardware, step-by-step instructions and our quick-start function allows you to get your system up and running quickly. Customer specific programming can then be completed at your convenience with the system already performing access control functions.*

### World-wide performance

*The innovative **ATRIUM** with embedded web server is fast, simple and secure. From any place in the world, you can do tasks such as user/card management, lock/unlock doors instantly, and view system events. The embedded web server provides instant results using any recent web browser, smart phone or tablet.*

*Alternatively, you can use the free software supplied and get full functionality and reporting from your local PC at your desk.*

### Flexibility

*Offer your customer exactly what is required by them - local and/or remote control and monitoring, reports of user movements and transactions, restriction of access to critical areas by the authorisation level or time schedules, verification of access by connection to CCTV cameras, email notification when something is wrong....and so much more.*

**Some features are becoming available during 2014 - please call us on 01628 531300 to talk about your installation**

MAIN FEATURES	ATRIUM 100 DOOR SYSTEM
Cards / Users	10,000
Doors/Readers	100
Areas	100
Monitored Inputs	500
Schedules /Periods	100
Access Levels	1000
Event Buffer	10,000
2-Door Expanders	4 per AC22
IP Camera Monitoring*	2 per door
Embedded Web Server	Yes
Free Software	Yes

**Go to [www.atrium.cdvi.co.uk](http://www.atrium.cdvi.co.uk) from your phone, tablet or PC to try Atrium and see its speed and simplicity for yourself**

\*Please check with CDVI Ltd for supported IP cameras



## ATRIUM - innovative and accessible



AC22KITB

- Can be used standalone, web or PC based
- Access your system over the internet
- Speedy installation
- Quick and simple system start
- Straightforward and user-friendly
- Fast and easy card enrolment
- Extremely competitively priced
- Free training in our demo room
- 5 year warranty

Try it at [www.atrium.cdvi.co.uk](http://www.atrium.cdvi.co.uk)

# ATRIUM

ACCESS CONTROL

An excellent product for your customer.....

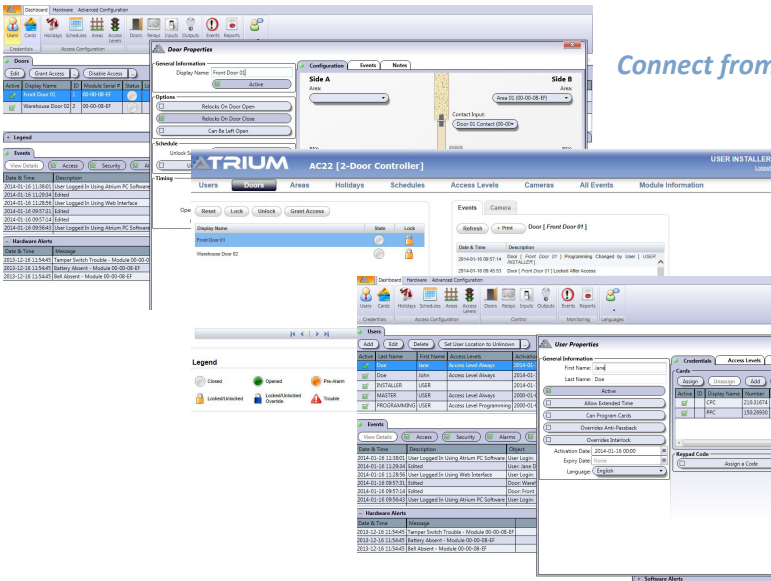

Connect from anywhere and monitor the site

Authorise card holders by door and time

Lock / unlock doors

.....an excellent product for you

Extremely simple and flexible wiring configuration

Web based monitoring



Local control

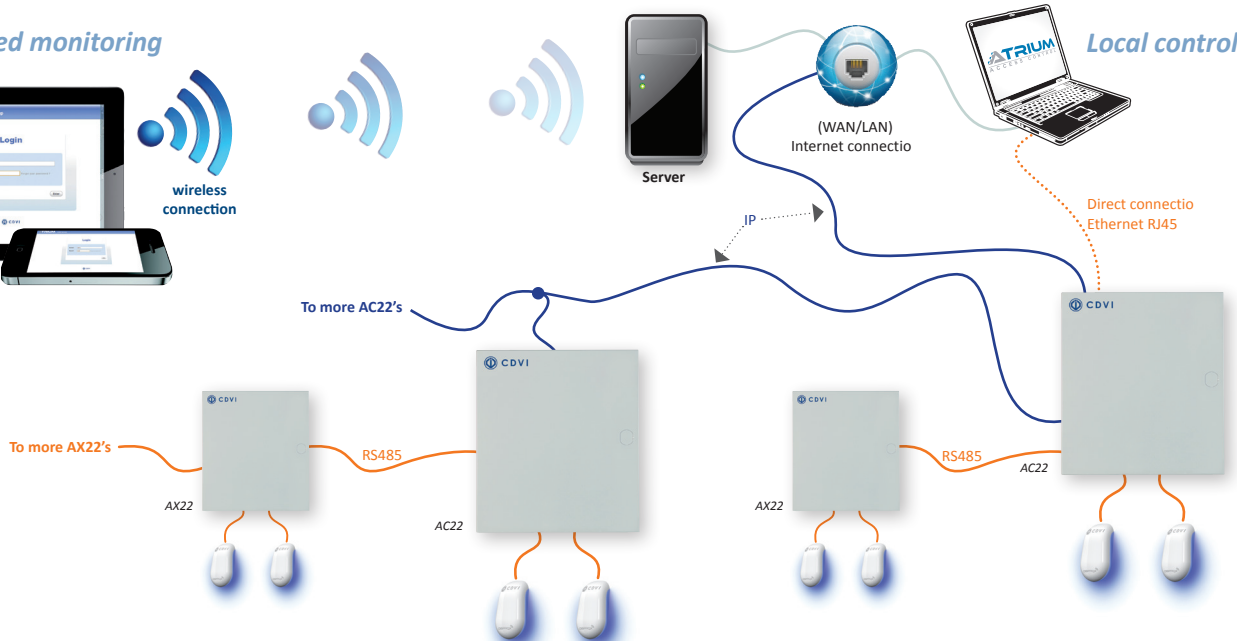

ATRIUM Controller

AC22

- 2-door controller with web-server
- Metal cased for security
- Built in PSU and battery charger
- Ample room to make connections
- Includes free software
- Includes quick start-up cards
- Available as kit with readers

- 230Vac input
- 3.3A @ 24Vdc
- 400 x 320 x 90mm

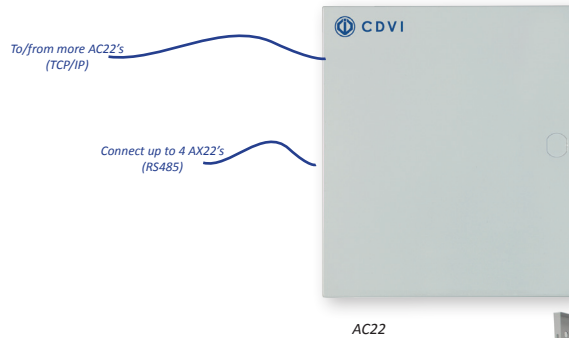

AX22

ATRIUM Expander

- 2-door expander
- Metal cased for security
- Built in PSU and battery charger
- Ample room to make connections

- 230Vac input
- 3.3A @ 24Vdc
- 290 x 280 x 80mm

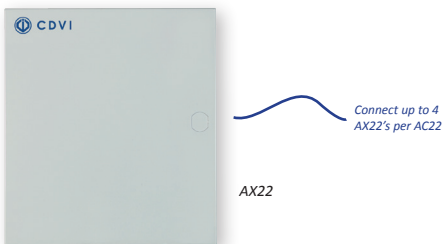



# Centaur<sup>®</sup>

## INTEGRATED ACCESS CONTROL

Centaur has evolved over the years to provide a simple and easy to manage system with the option to make use of its powerful features only if needed - this uncomplicated approach has enabled users to build their system as dictated by their requirements, and remove the feeling of having a system "too big for our needs".

From simple 2-door access control with central administration and reporting, to a fully featured system incorporating multi-sites with thousands of doors and cardholders, Centaur has proved it is capable of providing a simple to manage system regardless of computer literacy.

Full training is provided for the installer and end user, all training at our facility being free of charge.

- **Simple architecture**
- **Extremely cost effective**
- **Central administration**
- **Flexible control**
- **Suits all requirements**
- **Up to 16000 cards per site**
- **Up to 2048 doors per site**
- **Up to 64 sites**
- **Powerful reporting tools**
- **Integrates to 3rd party technology**
- **Free design and specification service**

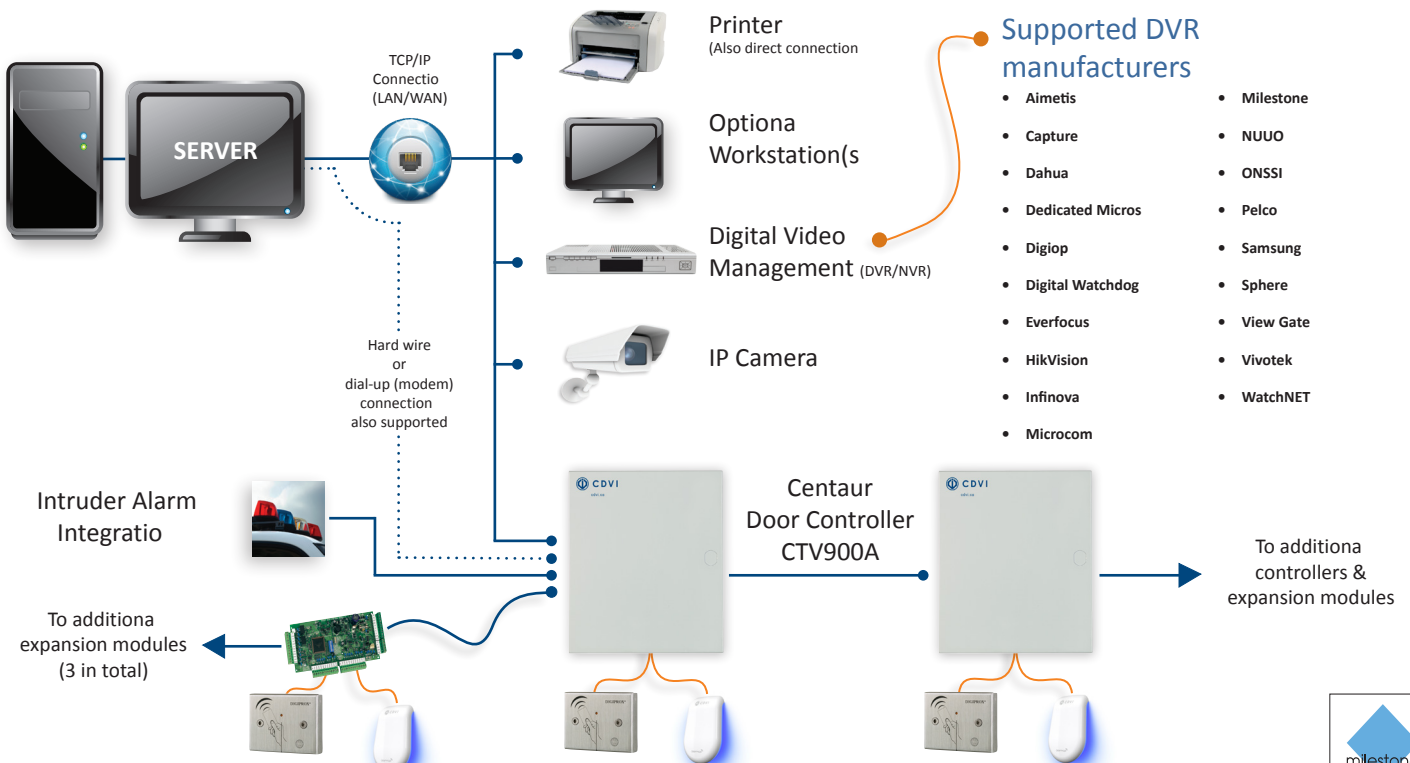

### Supported DVR manufacturers

- Aimetis
- Capture
- Dahua
- Dedicated Micros
- Digiop
- Digital Watchdog
- Everfocus
- HikVision
- Infinova
- Microcom
- Milestone
- NUUO
- ONSSI
- Pelco
- Samsung
- Sphere
- View Gate
- Vivotek
- WatchNET



## CTV900

2-door controller

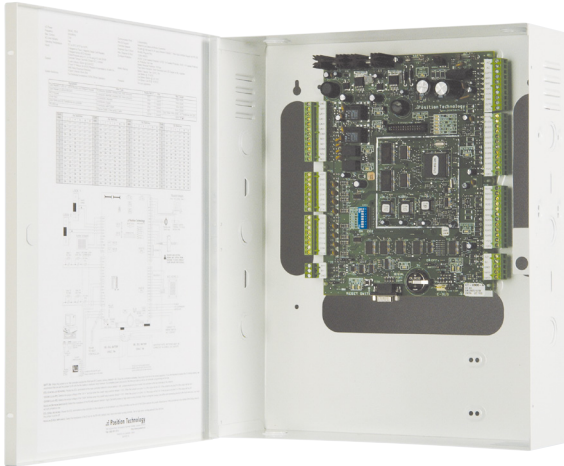

- **2-door intelligent controller**
- **Built-in power supply**
- **Secure metal case**
- **Ample space for cables**
- **Battery standby provision**

- 240Vac
- 2.5A maximum current
- Accepts 2 x 12Vdc, 7AH batteries
- 400 x 337 x 105mm

2-door expander

## CAA470

- **2-door expansion module**
- **Built-in power supply**
- **Secure metal case**
- **Ample space for cables**
- **Battery standby provision**

- 240Vac
- 2.5A maximum current
- Accepts 1 x 12Vdc, 7AH batteries
- 298 x 285 x 78mm

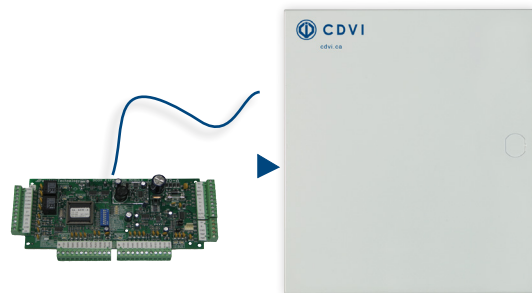

## MODULES

Software & plug-on modules



- **Software supplied on DVD**
- **Automatic set up**
- **Cardholder database**
- **Customised events and reports**
- **Visitor management**
- **Alarm management**
- **Interactive graphics maps**
- **Free software training**

**ONLINE READERS**
**NANO**

Compact reader

**NANOPW**

**NANOPB**

- *Stylish design*
- *Reflective backlight*
- *Audible and visual feedback*
- *Available in white or black*
- *Wiegand 26 bit*

- 12Vdc
- 120mA max
- 70 x 43 x 23mm

Narrow style reader

**STAR**

- *Stylish design*
- *Narrow style*
- *Reflective backlight*
- *Audible and visual feedback*
- *Available in white or black*
- *Wiegand 26, 30 or 44 bit*

- 12Vdc
- 120mA max
- 130 x 41 x 28mm

**STARPW**

**STARPB**
**SOLAR**

Standard reader

**SOLARPW**

**SOLARPB**

- *Stylish design*
- *Reflective backlight*
- *Audible and visual feedback*
- *Available in white or black*
- *Wiegand 26, 30 or 44 bit*

- 12Vdc
- 120mA max
- 130 x 90 x 35mm



## ONLINE READERS

### SOLARKP

Combined reader & keypad



SOLARKPW



SOLARKPB

- Stylish design
- Reflective backlight
- Touch sensitive keypad
- Card & PIN for increased security
- Audible and visual feedback
- Available in white or black
- Wiegand 26, 30 or 44 bit

- 12Vdc
- 120mA max
- 130 x 90 x 35mm

Combined reader & keypad

### KCPROX

- Backlit for convenience
- Narrow style to fit door frames
- Rugged stainless steel construction
- Card & PIN for increased security
- Audible and visual feedback
- Wiegand 26, 30 or 44 bit

- 12Vdc
- 120mA max
- 190 x 43 x 27mm



### DGLI

Stainless readers



DGLIWLC



DGLIFWLC

- Rugged design
- Suitable for harsh environments
- High grade stainless steel
- Audible and visual feedback
- Available as standard or narrow style
- Wiegand 26, 30 or 44 bit

- 12Vdc
- 120mA max
- 97 x 76 x 20mm (DGLIWLC)
- 140 x 35 x 22mm (DGLIFWLC)

**ONLINE READERS**
**GALEOW**

Rugged keypad



- Backlit for convenience
- Stylish & vandal resistant
- Secure surface mount
- Wiegand 26 bit

- 12-48Vdc/12-24Vac
- 100mA max
- 110 x 75 x 15mm

Long range reader

**DTRR1434**

- Up to 15m range
- Hands-free operation
- Ideal for car parks
- Audible and visual feedback
- Built-in antenna
- Wiegand 26 bit

- 12-30Vdc
- 40mA max
- 90 x 60 x 22mm

**WIEGAND RECEIVERS**

Radio receivers

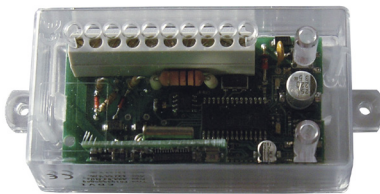
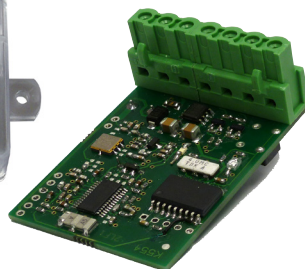
**SELWR433**

**DTFRW01**

- Up to 100m range
- Rolling code security
- Single channel wiegand output
- Optional tuned antenna
- Compatible with all CDVI transmitters  
see pages 48 & 49

- 12V AC/dc
- 12mA max
- 105 X 45 X 28mm (SELWR433)
- On board PCB connector (DTFRW01)

**SEA433**

ONLINE READERS

**SOLARMW**

Standard MIFARE readers



- Stylish design
- Reflective backlight
- Audible and visual feedback
- Available in white or black
- Wiegand 26, 30 or 44 bit

- 12Vdc
- 120mA max
- 130 x 90 x 35mm

Stainless Mifare reader







**DGLIMWLC**

- Rugged design
- Suitable for harsh environments
- High grade stainless steel
- Audible and visual feedback
- Wiegand 26, 30 or 44 bit

- 12Vdc
- 120mA max
- 97 x 76 x 20mm (DGLIWLC)



**CARDS & TAGS**

	<b>Reference</b>	<b>Description</b>			<b>Reference</b>	<b>Description</b>	
	METAL1	Robust prox fob, 10 pack			CPE	Clamshell prox card, 10 pack	
	<b>Reference</b>	<b>Description</b>			<b>Reference</b>	<b>Description</b>	
	PPC	Standard fob, 10 pack			DTXT5434	Hands-free active card	
	<b>Reference</b>	<b>Description</b>			<b>Reference</b>	<b>Description</b>	
	METAL	MIFARE fob, 10 pack			BV	MIFARE card, 10 pack	



**MORTICE MAGNETS - INTERNAL**
**V3ER / M300M**

300kg mortice magnet

- **Monitored**
- **Up to 300kg holding force**
- **No moving parts**
- **Fits AT300-H series housings**

- 12/24Vdc
- 500mA @ 12Vdc
- 228 x 39 x 27mm



400kg mortice magnet

**V4ER / M400M**

- **Monitored**
- **Up to 400kg holding force**
- **Optional housing**
- **No moving parts**

- 12/24Vdc
- 500mA @ 12Vdc
- 228 x 44 x 30mm

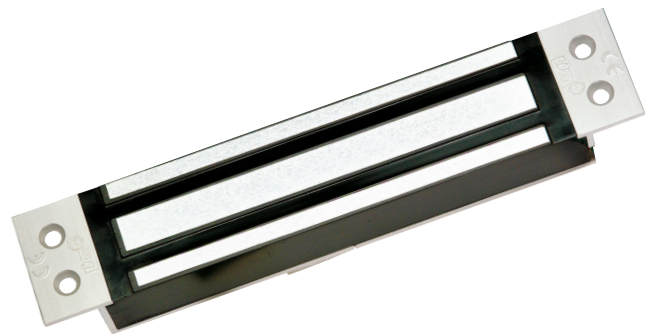
**V5E / M500**

500kg mortice magnet

- **Up to 500kg holding force**
- **No moving parts**
- **Mortice directly into door/gate frames**

- 12/24Vdc
- 500mA @ 12Vdc
- 288 x 64 x 37mm



## HORIZONTAL HOUSINGS - INTERNAL

### AT500

500kg mortice magnet

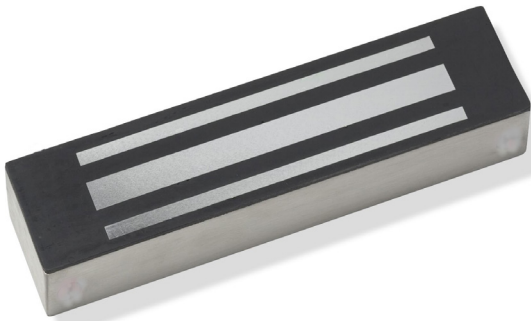

- **Monitored**
- **Up to 500kg holding force**
- **No moving parts**
- **Fits AT500-H series housings**

- 12/24Vdc
- 500mA@ 12Vdc
- 228 x 39 x 27mm

Architectural housings

### AT-H HOUSINGS

- **Surface mount**
- **SAA finish (Satin Anodised Aluminium)**
- **Easy installation**
- **Forms part of door frame**
- **Visually aesthetic**
- **RAL colour finishes available**
- **Single & double door versions**
- **Horizontal or vertical fix models**
- **End caps and fixing kit**

- **Dimensions (LxWxD):**
  - AT300-1 series = 998 x 45 x 45mm
  - AT300-2 series = 1998 x 45 x 45mm
  - AT500-1 series = 995 x 70 x 50mm
  - AH500-2 series = 1995 x 70 x 50mm



**Note:**

Each housing is supplied with end-caps, which are fitted once the housings are cut to fit the door(s).

We do offer a cutting service, where we will cut the housings to measurements supplied by you - these measurements to be supplied to us in a written form.

Magnets are not included in the housing prices.

**SURFACE MAGNETS - INTERNAL**
**V1SR / S180**

Micro magnet



- **Surface mount**
- **Monitored**
- **Up to 180kg holding force**
- **No moving parts**

- 12/24Vdc
- 550mA @ 12Vdc
- 167 x 34 x 20mm

Mini magnet

**V3 / S300 Series**

- **Surface mount**
- **Up to 300kg holding force**
- **Innovative visual indication**
- **No moving parts**
- **Designed with safety features**
- **Security "catch" ropes**

- 12/24Vdc
- 550mA @ 12Vdc
- 225mA @ 24Vdc
- 248 x 45 x 26mm single
- 496 x 45 x 26mm double



*Includes safety ropes to catch magnet in case of loose fixings. Rounded ends to reduce impact damage. Compatible with all CDVI bracketry and accessories.*

**V4 / S400 Series**

Midi magnet



- **Surface mount**
- **Up to 400kg holding force**
- **Innovative visual indication**
- **No moving parts**
- **Designed with safety features**
- **Security "catch" ropes**

- 12/24Vdc
- 550mA @ 12Vdc
- 225mA @ 24Vdc
- 255 x 50 x 27mm single

*Includes safety ropes to catch magnet in case of loose fixings. Rounded ends to reduce impact damage. Compatible with all CDVI bracketry and accessories.*

## SURFACE MAGNETS - INTERNAL

### V5 / S500 Series

Standard magnet

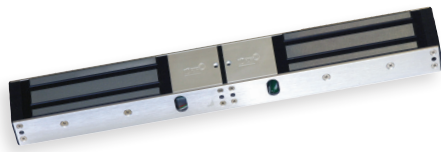

*Includes safety ropes to catch magnet in case of loose fixings. Rounded ends to reduce impact damage. Compatible with all CDVI bracketry and accessories.*

- **Surface mount**
- **Up to 500kg holding force**
- **Innovative visual indication**
- **No moving parts**
- **Designed with safety features**
- **Security "catch" ropes**

- 12/24Vdc
- 550mA @ 12Vdc
- 225mA @ 24Vdc
- 266 x 66 x 40mm single
- 532 x 66 x 40mm double

Magnetic locks

### C Series

- **Mortice & surface mount**
- **Monitored as standard**
- **Entry level products**
- **12 month warranty**

C3 series, up to 300kg  
C5 series, up to 500kg

C3M11 = 228 x 38 x 27mm  
C3S11 = 255 x 45 x 26mm  
C3S12 = 504 x 45 x 26mm  
C5S11 = 273 x 65 x 40mm  
C5S12 = 540 x 65 x 40mm

- 12/24Vdc
- 550mA @ 12Vdc (per side if double)
- 225mA @ 24Vdc (per side if double)





**ELECTROMAGNETIC LOCKS - INTERNAL**
**DPM Series**

Door position monitoring

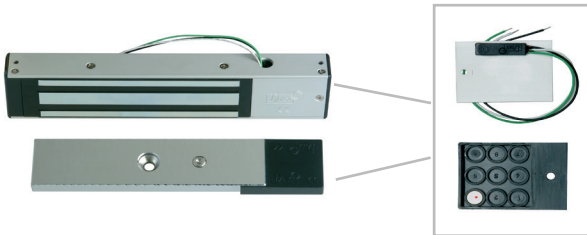

- Retrofit to V-series surface magnets
- Signals door status (not lock)
- Changeover signalling (Com, NO, NC)
- Ideal for access control monitoring
- Suitable for auto-relock

## Radio magnet &amp; transmitter kit

**RF-MAGNET**
**RF-MAGNET-KIT1**

- Surface mount V3S magnet
- No moving parts
- Fail safe
- Built-in receiver
- 10 x user capacity
- 2 x TX26-E2 transmitters

- 248 x 45 x 26mm
- 10 user receiver
- 12Vdc
- 580mA

**TX26-E2/E4**

- 433.92MHz
- 2 or 4 channel
- Keeloq code
- 83 x 48 x 16mm.
- Modulation: AS
- Battery: L1028-12V

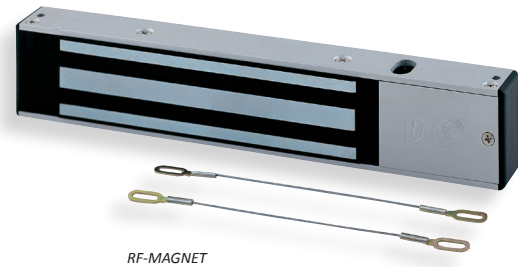

RF-MAGNET



TX26-E2

TX26-E4

ACCESSORIES FOR ELECTROMAGNETIC LOCKS

**Z&L** Fixing Solution for Magnets & Armatures

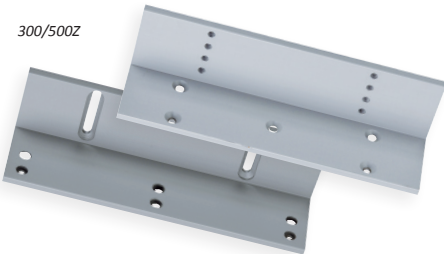

Example showing outward opening door

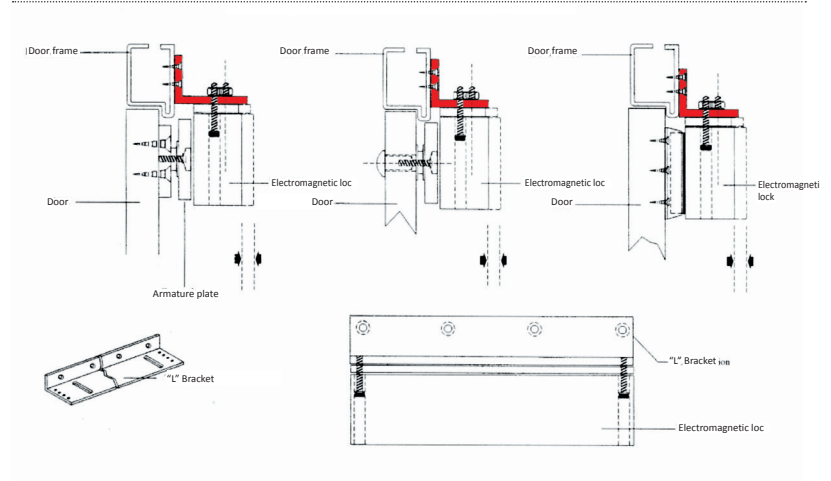

Example showing inward opening door

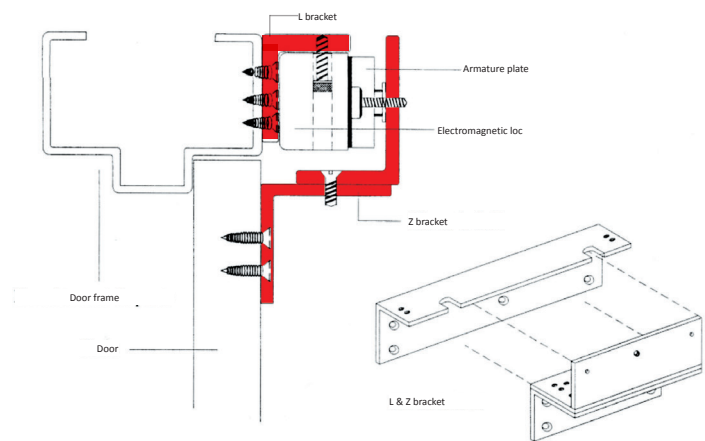

## ACCESSORIES FOR ELECTROMAGNETIC LOCKS

### AF & AS Series Armature plate housings



300AS

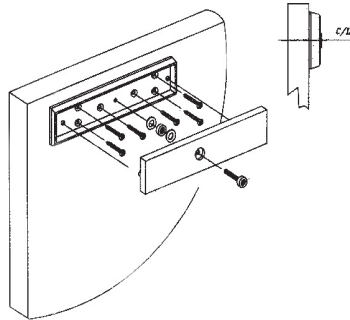

- Surface and flush armature housings
- Removes need to drill through door
- Neat, bevelled edge finish (AS)
- Economy plate version (ASE)

300AS = 188 x 54.5 x 15mm  
500AS = 193 x 74 x 14mm

### Glass Door Fixings

### UBK & ADH Series

- The UBKs are U-brackets for mounting magnetic locks on glass doors:
  - UBK-U = armature plate installation
  - UBK-P = electromagnetic lock/bracket installation
- Suitable for glass 8-14mm thickness

- UBK-U Dimensions (L x W x D): 185 x 62 x 33.5mm
- UBK-P Dimensions (L x W x D): 266 x 62 x 33.5mm

Requirements for inward opening door:  
2 No. UBK-P, 1 No. Z&L bracket

Requirements for outward opening door:  
1 No. UBK-U, 1 No. UBK-P, 1 No. L bracket

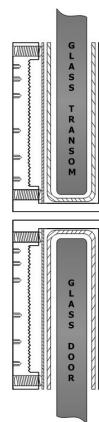

## EXTERNAL ELECTROMAGNETIC LOCKS

### External Series

### Flush & surface magneti locks

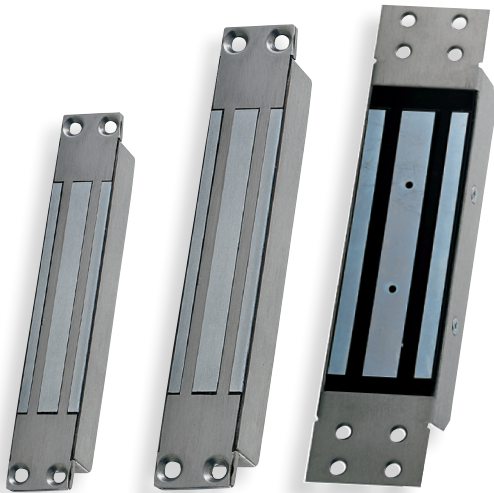

I180ER/EM180

I300ER/EM300

I500E/EM500

- **Stainless steel construction**
- **Extremely reliable - no moving parts**
- **Fail safe**
- **Electronics internally protected**
- **Flush & surface versions**
- **For use in harsh environments**
- **Face & side mount (surface magnets)**

- 12 or 24V DC
- 550mA @ 12Vdc
- 225mA @ 24Vdc

#### **I180ER/EM180 / I180SR/ES180**

- EM180 (flush) 206 x 32 x 25mm
- ES180 (surface) 175 x 33 x 24mm
- Holding force up to 180kg
- Monitored

#### **I300ER/EM300**

- 228 x 39 x 27mm
- Mortice mount
- Holding force up to 300kg
- Monitored

#### **I400SR/ES400**

- 230 x 43 x 30mm
- Surface mount
- Holding force up to 400kg
- Monitored

#### **I500E/EM500**

- 288 x 64 x 38mm
- Mortice mount
- Holding force up to 500kg

#### **I500SR/ES500**

- 230 x 61 x 40 mm
- Surface mount
- Holding force up to 500kg
- Monitored

#### **P250D80**

- 12/24Vdc
- 80mm diameter, 38mm depth



I180SR/ES180

I400SR/ES400

I500SR/ES500

P250D80



## ELECTROMAGNETIC LOCKS

### BO600RP

### Vertical Retrofit Housing Series

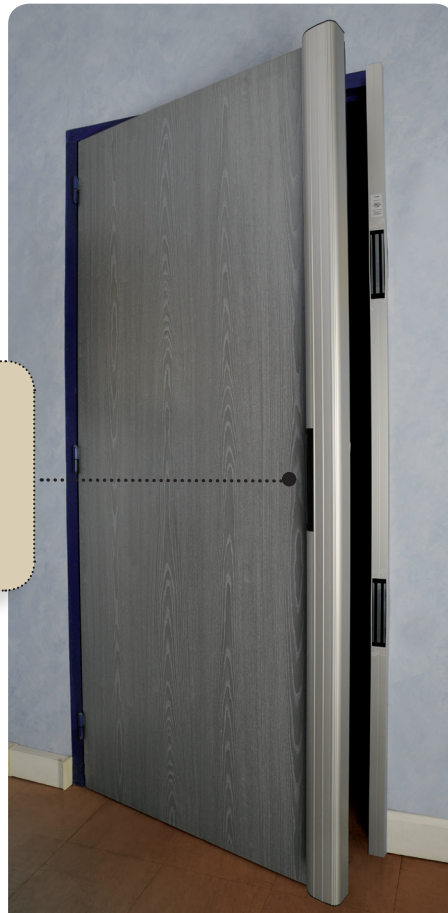

BO600RP

- *Secure surface mount*
- *Holding force spread evenly - no door flexing*
- *Easy & quick installation*
- *Pre assembled*
- *SAA (satin anodised aluminium) finish as standard*
- *Aesthetic*
- *Monitored magnets*
- *Suitable for metal, wood and glass doors*
- *Ideal for retrofit applications*
- *Pre-drilled mounting holes*

#### Options:

- *Full length handle 2500mm*
- *Mid position handles 400mm & 600mm*
- *Aluminium rail spacer to pack out handle*
- *Aluminium cable tray for cable management*
- *Installation on glass door (UBK25)*
- *RAL colour*
- *Cut to size*

- *Holding force: up to 300kg per magnet*
- *Dimensions (L x W x D):*  
 BO600RP/BO600RP3V 2500 x 105 x 63mm  
 P300RP 400 x 105 x 63mm  
 P600RP 600 x 105 x 63mm
- *12/24Vdc*  
 550mA @ 12Vdc (per magnet)  
 275mA @ 24Vdc (per magnet)

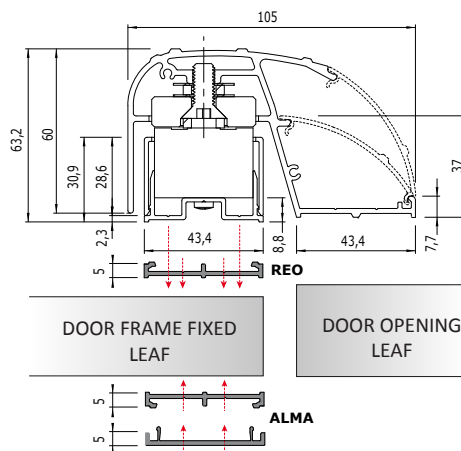

P300RP  
40CM Handle

## ELECTROMAGNETIC LOCKS

### BO600RH

### Horizontal Retrofi Housing



- *Secure surface mount*
- *Holding force spread evenly*
- *Easy & quick installation*
- *Pre assembled*
- *SAA finish as standard*
- *Aesthetic*
- *Monitored magnets*
- *Suitable for metal, wood and glass doors*
- *Ideal for retrofit applications*
- *Pre-drilled mounting holes*

■ **Options:**

- *Aluminium rail spacer to pack out handle*
- *Aluminium cable tray for cable management*
- *Installation on glass door (UBK25)*
- *RAL colour*
- *Cut to size*

- Holding force: Up to 300kg per magnet
- Dimensions (L x W x D): 925 x 105 x 63mm
- 12/24Vdc
- Consumption  
550mA @ 12Vdc (per magnet)  
275mA @ 24Vdc (per magnet)

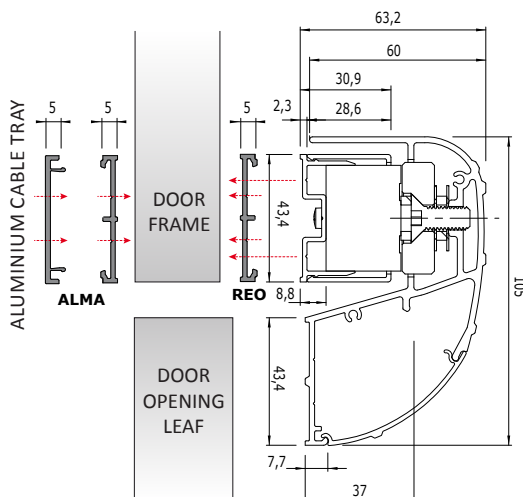

## RETROFIT HOUSING AND HANDLE ACCESSORIES

**REO**

### Aluminium rail spacer



- **Stackable to pack out handle**
- **Aluminium rail spacer for:**
  - BO600RH horizontal retrofit housing
  - BO600RP vertical retrofit housing
  - P300RP and P600RP handles
- Dimensions (L x W x D): 2500 x 43 x 5mm
- Material: SAA finis

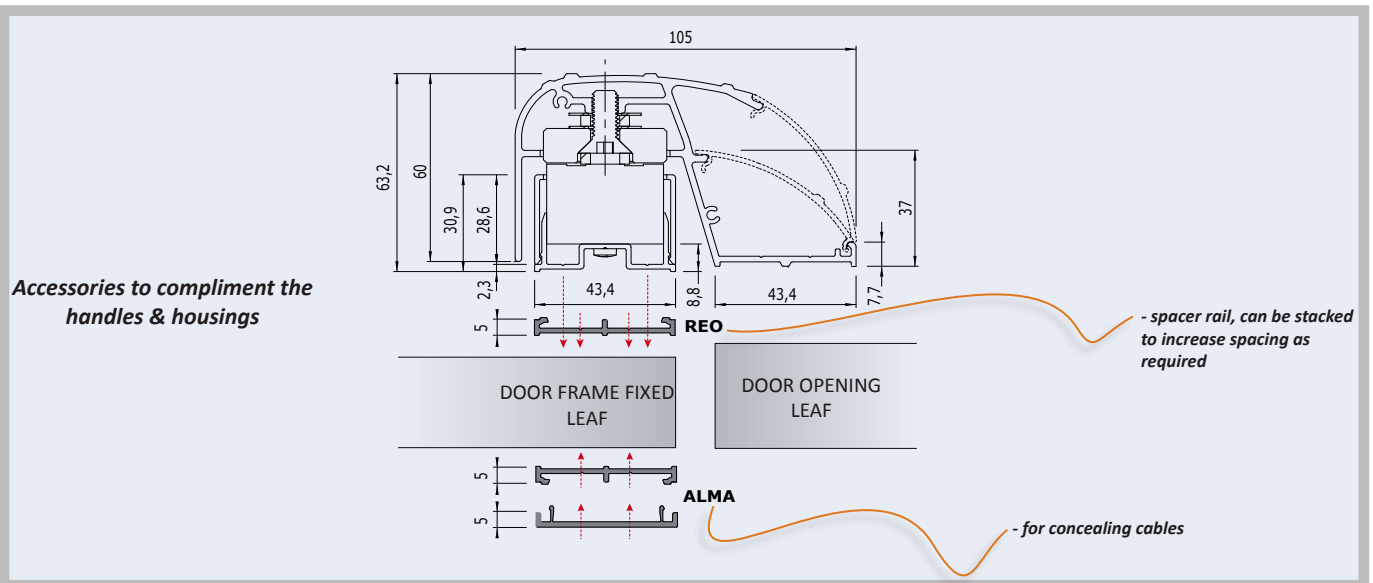

**ALMA**

### Aluminium Cable tray

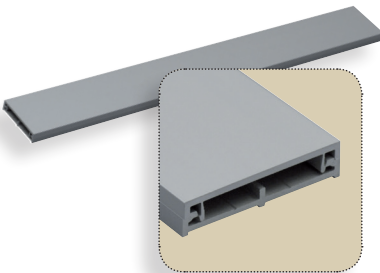

- **Ideal for hiding cables**
- **Can be adhered to glass doors/frames**
- Dimensions (L x W x D): 2500 x 43 x 10mm
- Material: SAA finis

## RETROFIT HOUSING AND HANDLE ACCESSORIES

### Cable tray & spacer kits

REOMA

- Kits include 2 cable trays and 2 spacers
- 600mm & 2500mm kits available
- Material: SAA finish

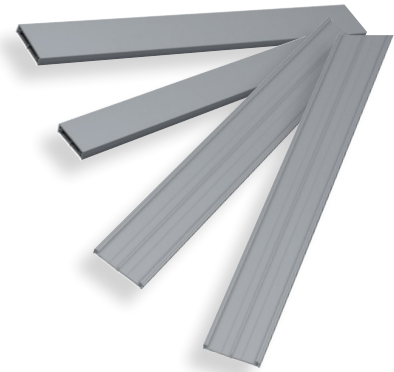

CABB

### Extension cable for retrofit housing (2 electromagnetic locks)



- Extension cable with terminal block
- Compatible with all Diax® retrofit housings
- Length: 2000mm.

### Glass door U-bracket

UBK25

- Full length U bracket
- Rubber glass protector

Requirements for single glass door, wood/metal frame:

1 No. UBK25

Requirements for single glass door & glass frame:

2 No. UBK25

- Glass 8-14mm thick

- Dimensions (L x W x D): 2500 x 62 x 33.5mm





## ELECTROMAGNETIC LOCKS

### BO800 SERIES

### Architectural Locking Solution



- *Secure surface mount*
- *Holding force spread evenly - no door flexing*
- *Easy & quick installation*
- *Pre assembled*
- *SAA finish as standard*
- *Aesthetic*
- *Monitored magnets*
- *Suitable for metal, wood and glass doors*
- *Ideal for retrofit applications*
- *Pre-drilled mounting holes*

■ **Options:**

- *Full length handle 2500mm*
- *Mid position handles 400mm & 600mm*

- Holding force: up to 400kg per magnet
- Dimensions (L x W x D):
  - BO800RN/BO1200RN 2500 x 136 x 68mm
  - BO800RN3M/BO1200RN3M 3000 x 136 x 68mm
  - PBO400RN40 400 x 136 x 68mm
  - PBO800RN60 600 x 136 x 68mm
- 12/24Vdc
  - 550mA @ 12Vdc (per magnet)
  - 275mA @ 24Vdc (per magnet)

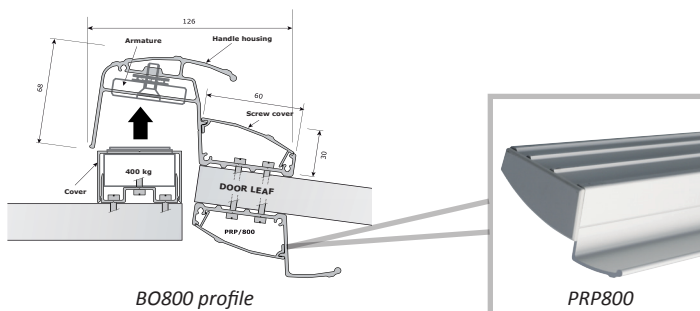

IT REALLY IS A SIMPLE STORY.....



1 - Prepare for installation



2 - Fit the pre assembled magnet housing

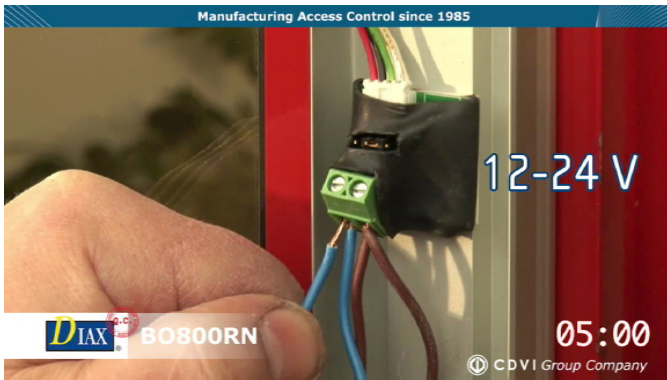

3 - Connect the wiring



4 - Snap on the magnet housing cover



5 - Align the armature handle



6 - Drill and fix the armature handle



7 - Snap on handle cover, and test.

.....QUICK, SIMPLE, SECURE

Visit [www.youtube.com/watch?v=y4PezoEWOQM](http://www.youtube.com/watch?v=y4PezoEWOQM) to view the complete movie, and see for yourself how easy the unit is to install.

## FIRELOCK

### FIRELOCK Lock which operates under side load



*The new re-launched version of the FIRELOCK from CDVI offers high quality, fail safe locking with the important feature of operation under side-load. Firelock is a high performance and versatile lock to suit many requirements.*

- For use on emergency exits
- Non-handed
- 20mm stainless bolt
- Holding Force up to 500kg
- Tested to operate at 100kg side load
- Fail safe
- Robust
- Monitored as standard NO/NC
- For single or double door use
- Optional: stainless surface housing

- 12Vdc or 24/48Vdc
- 500mA @ 12V dc
- 250mA @ 24V dc
- 125mA @ 48Vdc
- 350 x 34 x 48mm (lock)
- 150 x 34 x 22mm (keeper)

### Traditional shearloc P/SHL1200

- 30mm wide
- 6mm gap tolerance
- 1200kg shear force
- Monitored
- Flush (surface housing available)

- 12-24Vdc
- 500mA, inrush 2.2A @ 12Vdc
- 250mA, inrush 1.1A @ 24Vdc
- 267 x 30 x 34mm (lock)
- 267 x 30 x 34mm (armature)





## SHEARLOCKS

### Self aligning shearlock

**POWERMAG**

- **Patented self-aligning feature**
- **Compact**
- **Fail safe**
- **Monitored**
- **800kg shear force**
- **Flush (surface housing available)**
  
- 12/24Vdc
- 460mA @ 12Vdc  
230mA @ 24Vdc
- 243 x 25 x 22mm (lock)  
243 x 25 x 35mm (armature)



### CZ3000/CSL30

### Self aligning shearlock



- **Patented self-aligning feature**
- **Fail safe**
- **Monitored**
- **1500kg shear force**
- **Flush (surface housing available)**
  
- 12/24V dc
- 600mA @ 12V dc  
300mA @ 24V dc
- 230 x 31 x 27mm (lock)  
230 x 30 x 37mm (armature)

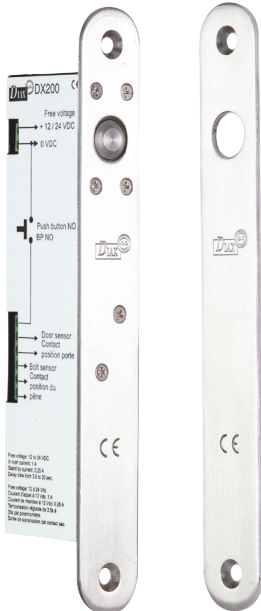

**ELECTRIC LOCKING**
**DX200**
**Solenoid bolt**

- **Fail safe**
- **Economical**
- **Monitored**
- **Relock timer**

- 12-24Vdc
- 250mA, inrush 1.0A @ 12Vdc
- 140mA, inrush 500mA @ 24Vdc
- 212 x 48 x 22mm

**Double actio lock**
**SDA**

- **Fail safe or fail secure**
- **Lock status monitoring**
- **Double action (swing doors)**
- **Euro cylinder provision**
- **High grade stainless steel**
- **Optional backsets**

- 12Vdc
- 255mA fail safe version
- 320mA fail secure version
- 255 x 25 x 43mm (25mm backset)
- 255 x 25 x 48mm (30mm backset)
- 255 x 25 x 53mm (35mm backset)



## ELECTRIC LOCKING

### MVM/MVA

### Motorised bolt



- *Non handed motorised bolt*
  - *Surface mount*
  - *With or without manual override*
  - *Suitable for outdoor use*
  - *Audible signal for locking error and unlocked mode*
  - *Includes round cylinder & keys*
  - *Nylon gears*
- 12Vdc
  - 20mA, inrush 410mA
  - 126 x 96 x 42mm (lock)  
96 x 40 x 36mm (keeper)

### Magneti door holder

### VIR

- *Wall/floor mount*
- *Test button*
- *50kg holding force*
- *Universal armature*

- 24Vdc
- 80mA
- 80 x 70 x 42mm (VIR5)  
113 x 70 x 65mm (VIRP5)



VIR5024/VIR5

SUP-VR-REG

VIRP5024/VIRP5

**ELECTRIC STRIKES**
**G & S SERIES**
**Euro Style**

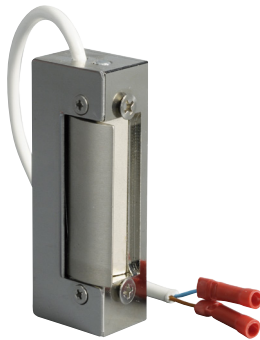
 NON-SYMMETRICAL  
STRIKE KIT

 FIRE RATED  
STRIKE

- **Non-symmetrical (G series)**
- **Symmetrical (S series)**
- **Left or right handed**
- **Adjustable jaw option**
- **Built-in suppression**
- **Available in kit form**
- **Fire rated available**
- **Surface & flush options**
  - Voltage: 12 & 24Vac/dc
  - Current: AC/DC
    - 12Vdc = 630mA (380mA constant rated)
    - 12Vac = 540mA
  - Current for fail safe:
    - 12Vdc = 200mA
    - 24Vdc = 100mA

- **Stainless steel faceplates**
- **Surface Rim cases**

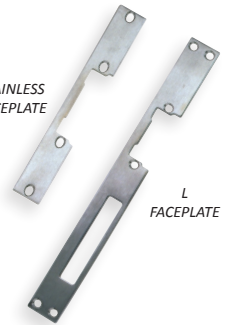
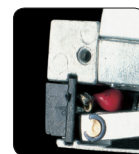

T204

 STAINLESS  
FACEPLATE

 L  
FACEPLATE

 INTERNAL  
SUPPRESSION

 ADJUSTABLE  
JAW

## ELECTRIC STRIKES

### ARUM

#### ANSI reversible strike



ARUM C/W  
LONG FACEPLATE



SHORT FACEPLATE

- *Stainless steel jaw*
- *Reversible - fail secure/fail safe*
- *Monitored as standard*
- *Long and short faceplate included*

- Voltage: 12Vdc
- Current: 250mA nominal
- Lock body: 86 x 38 x 86mm (including lip)
- Short faceplate: 124 x 32 x 2mm
- Long faceplate: 165 x 32 x 2mm

### Dead bolt strike

### DBR

- *Heavy Duty*
- *Standard moulded body*
- *Stainless steel jaw*
- *Fail secure & fail safe models*
- *Monitored as standard*

- Voltage: 12Vdc
- Current: 360mA nominal





**EXIT DEVICES PUSH BUTTONS**
**RTE PLASTIC SERIES**

Internal, light to medium tra use



RTE0015



RTE0025



BPDOORF

- Surface as standard
- Sturdy plastic
- UK back-box format
- Styles to suit all needs
- Standard & architrave
- Internal use

- Dimensions:
  - standard = 83 x 83 x 29mm
  - architrave = 83 x 33 x 29mm

Medium &amp; heavy tra use

**RTE-SS SERIES**

- Flush or surface
- Stainless steel
- High impact buttons
- UK back-box format
- External or internal use

- Dimensions:
  - 85 x 85 x 30mm standard surface
  - 85 x 85 x 2mm standard flus
  - 85 x 38 x 29mm architrave surface
  - 85 x 38 x 2mm architrave flus



RTE5F



RTE5SD



RTE5AF

EXIT DEVICES PUSH BUTTONS

RTE ALL-ACTIVE SERIES

High profile high impact



RTE85E-F



RTE85DL-F



RTE85E-S

- All-active target area
- Push to make & break
- Flush mount fits UK backbox
- High quality stainless steel
- "EXIT" or "Wheelchair Logo"

- Dimensions: 85 x 85 x 42mm surface  
85 x 85 x 14mm flus

High profile, large target area

RTE ALL-ACTIVE SERIES

- Large all-active target area
- Push to make & break
- Flush & surface available
- High quality stainless steel
- Suitable for DDA environments

- Dimensions:
  - standard = 130 x 130 x 42mm surface  
130 x 130 x 14mm flus
  - architrave = 114 x 43 x 43mm surface only

RTEPTO



RTEPTOD-A



RTEPTOD



RTED

**EXIT DEVICES PUSH BUTTONS & EMERGENCY DOOR RELEASE**
**DBB SERIES**

Combined exit button &amp; emergency door release



DBB-21-02



DBB-21-04



DBB-22-02



DBB-22-04

- *Surface as standard*
- *Stainless buttons*
- *Convenient and neat*
- *UK back-box format*
- *Styles to suit all needs*
- *Internal use*

- 188 x 98 x 57mm
- Exit button:
  - Stainless or green dome
  - Push to make & break
  - High impact
- Emergency door release:
  - Resettable or break-glass
  - Double pole
  - Reset keys included



MX-03

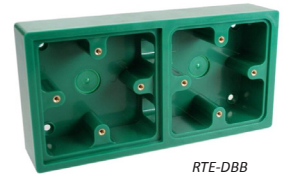

RTE-DBB

## Emergency door release

**EM SERIES**

- *Emergency unlock*
- *Break-glass or resettable*
- *Double-pole as standard*
- *UK back-box format*
- *Internal use*

- 86 x 86 x 50mm
- Reset keys included



EM200



EM201



MX-03

EXIT DEVICES KEY SWITCHES

KS SERIES

Key switches

- **Keyed alike or keyed to differ**
- **Stainless steel**
- **Surface, option of flush**
- **Supplied with 2 keys (round version)**
- **Momentary or maintained versions**
- **Euro profile option (cylinder not included)**
- **3-position keyswitches available**

- Dimensions:
- 85 x 85 x 30mm standard surface
- 85 x 85 x 2mm standard flus
- 85 x 38 x 29mm architrave surface
- 85 x 38 x 2mm architrave flus

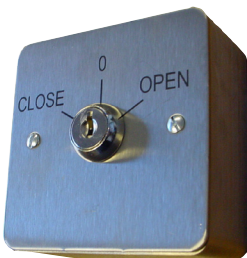

3-position keyswitch



Digiway Plus keyswitch



**EXIT DEVICES**
**RTE-IR**
**Infrared exit device**

RTE-IR-F

 Surface  
back box

- *Adjustable trigger range*
- *Red/green indicators*
- *Stainless faceplate*
- *Simple to install*
- *Fits standard UK back box*
- *Surface version available*

- 86 x 86 x 8mm
- 12-20Vdc
- 1A contacts @ 30V
- 0.5 - 20 seconds adjustable latch tim

**Microwave sensor**
**DWHR50-UNI**

- *Small and neat design*
- *Adjustable detection area*
- *Easy to install*
- *Ideal for swing and sliding doors*
- *Internal & external use*

- 120 x 70 x 42mm
- 12-30Vdc/12-24Vac
- 80mA max

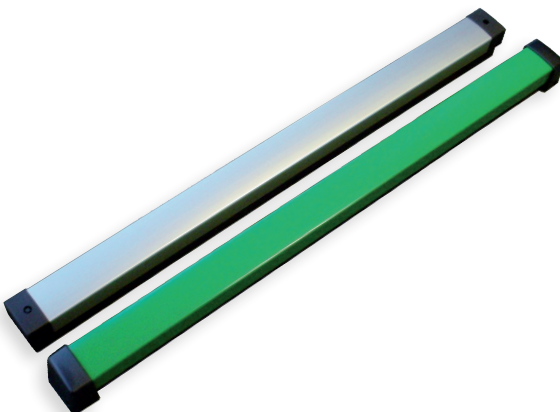
**MICROSWITCH PUSH BARS**
**Ideal for releasing magneti locks**

- *SAA standard finish*
- *Green available as special order*
- *Double pole switch COM/NC/NO*
- *Simple surface mount*
- *Can be cut down to 680mm*

- 860 x 62 x 60mm
- 3A contacts @ 24V

DOOR LOOPS & ACCESSORIES

**DOOR LOOPS & HINGES**

Flexible power transfer

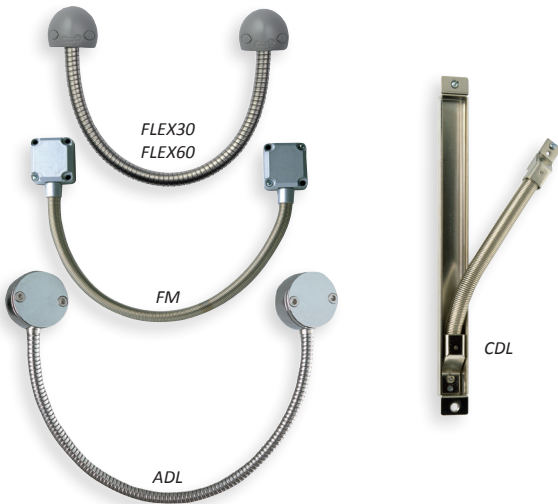

- Facilitates transfer of cable/power from frame to door leaf
- FLEX30 & FLEX60 excellent value with stainless steel loop and metal end caps
- FM traditional door loop, 45CM
- ADL includes vandal resistant screws, 60CM
- CDL concealed on hinge-line Flexible loop has 7mm internal diameter
- 2 & 3 pin transfer hinges Spring-loaded contacts, max 3A

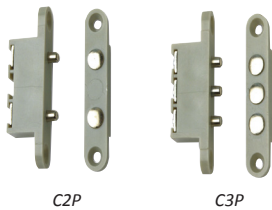

Accessories to compliment your system

**TIMERS & RELAYS**

- 7-day timers, various input voltage
- Handy relay module
- Delay module for fail safe locks
- 0-20 second pcb timer
- Voltage reducer 24Vdc to 12Vdc
- All very useful accessories

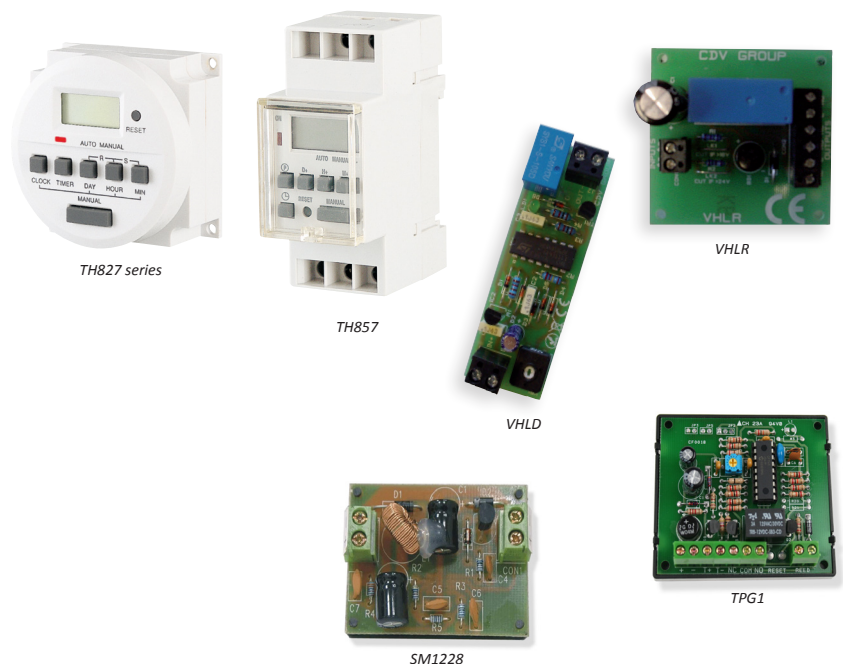

**INFRARED PHOTOCELLS**
**SEF SERIES**

Flat fi ed photocells



- *Active infrared photocells*
- *Flat style for discreet mounting*
- *5 or 10M range*
- *Internal or external use*
  
- *12-24V ac/dc*
- *Fixed optics*
- *IP55*
- *90 x 60 x 22mm*

 Adjustable & vandal resistant **SEF SERIES**

- *Active infrared photocells*
- *Adjustable*
- *10M or 20M range*
- *Vandal resistant option*
- *Internal or external use*
  
- *12-24V ac/dc*
- *Adjustable optics*
- *IP55*
- *90 x 60 x 60mm (SEF2420)*
- *99 x 69 x 69mm (SEF2410AVN & 20AVN)*



SEF2420



SEF2410AVN/20AVN

POWER MANAGEMENT POWER SUPPLIES

PSU SERIES

DC metal cased with charger

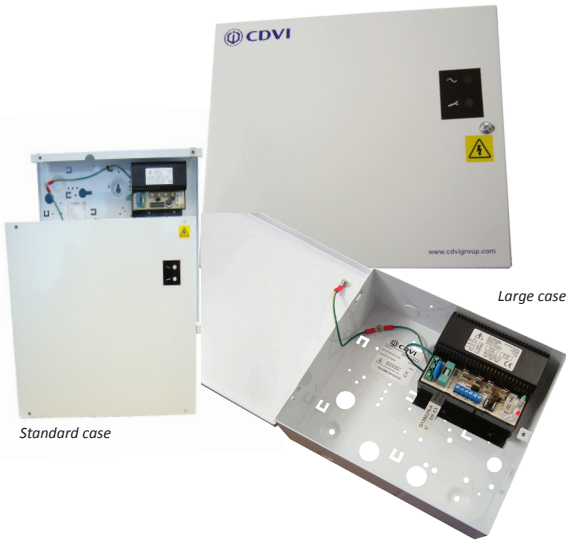

- Full current to load
- Additional battery charging current
- Short circuit protection
- Mains transient protection
- Battery current limiting circuit
- 12Vdc & 24Vdc available
- 1A, 2A & 3A versions

- 230 x 200 x 80mm standard case
- 355 x 330 x 80mm large case
- 8AH battery capacity standard case
- 18AH battery capacity large case



DC & AC without charger

PSU SERIES

ARD Range

- DIN rail mount
- Sturdy polycarbonate
- Regulated (not ARD212)
- Primary & secondary protection
- 12Vdc & 24Vdc models
- Integral relay/timer model

- 142 x 92 x 60mm
- Input voltage 230Vac

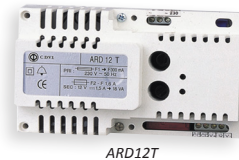

CA Range

- Economical
- AC transformer
- 4/8/12V ac, 12VA (CA1A)
- 12/24V ac, 24VA (CA1R)

- 81 x 56 x 43mm CA1A
- 90 x 65 x 55mm CA1R

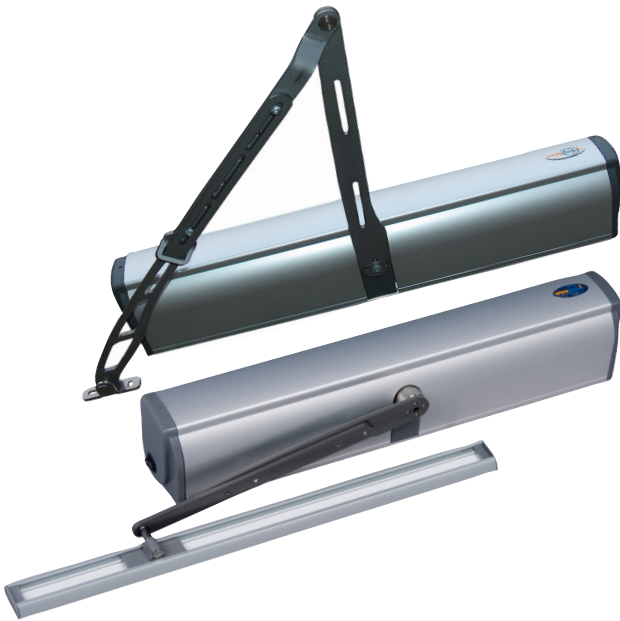

**DOOR AUTOMATION**
**DIGIWAY PLUS**
**Door automatio**

- **SAA standard finish**
- **Inward or outward opening doors**
- **LCD prompt for easy installation**
- **Self learning mode**
- **No end stops required**
- **Built-in radio receiver**
- **Includes radio transmitter**
- **Integral battery standby**
- **Fully programmable**

- 511 x 110 x 90mm
- 230Vac
- Only weighs 5kg
- 13.5Vdc available for sensors
- 12Vdc, 1.0A available for locks

*Free installer training at our facility in High Wycombe  
Please check suitability of door and application with CDVI*

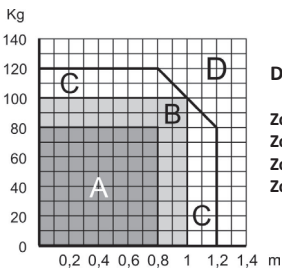

**Door weight/height graph:**  
**Zone A** - High traffic u  
**Zone B** - Low traffic u  
**Zone C** - Use at reduced speed  
**Zone D** - Not allowed



*We welcome installers to attend our hands-on training modules held at our facility in High Wycombe. We cover two main topics which are beneficial to you the installer:*

- 1. The success of your installation. Each door is different, so we ensure you are familiar with all aspects of installation and set up depending on the door size and the type of use.*
- 2. We ensure you understand the original BS7036 and the new EN16005 regulations, and we will instruct you how to complete a risk assessment and be familiar with the devices to satisfy the regulations.*

*These training modules are free of charge, so call us now to book your place on 01628 531300.*

**DOOR AUTOMATION**

**SENSORS & SAFETY**

Devices & compliance kits

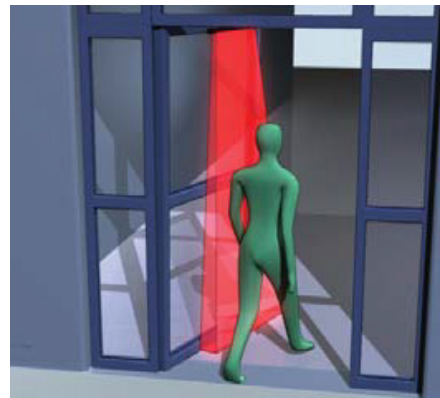
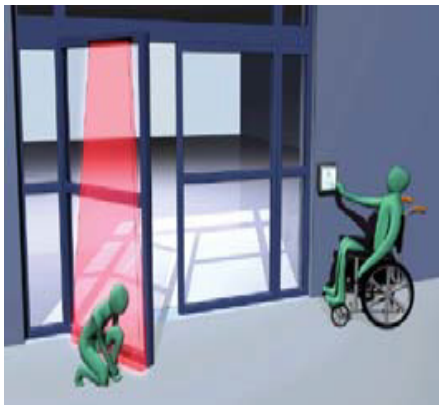

DWSS-3M2/C



DWS-KCSIGN



DWS-FGW



DWS-ADSIGN

DWSS-3M2/C

- Infrared safety sensor
- Positional sensing
- Easy to install
- Monitored sensor for EN16005

- 700 x 45 x 45mm
- 12/24V ac/dc
- Changeover relay

EN16005

- Complete kits available
- Single & double door

*Free installer training at our facility in High Wycombe to EN16005 compliance standard*

**Explanation of kits:**

EN16005-KIT-U	DWPS102U, 2 x DWSS-3M2/C, DWS-FGW, 2 x DWS-KCSIGN, 2 x DWS-ADSIGN
EN16005-KIT-UD	2 x DWPS102U, 4 x DWSS-3M2/C, 2 x DWS-FGW, 4 x DWS-KCSIGN, 4 x DWS-ADSIGN, DWPCS

Digiway Plus  
keyswitch



**TRANSMITTERS**
**TX SERIES**
**Hand-held transmitters**

- Full range of hand-held transmitters
- Rolling code
- Integral prox option
- Wiegand output
- Ideal for vehicle automation
- 1, 2 & 4 channel models
- Up to 200m range

- Frequency: 433.92MHz
- Modulation: AS
- Range: 100-200M in open space
- Dimensions:
  - 83 x 48 x 16mm (TX26E1, E2 & E4)
  - 60 x 36 x 16mm (TX26AM2)

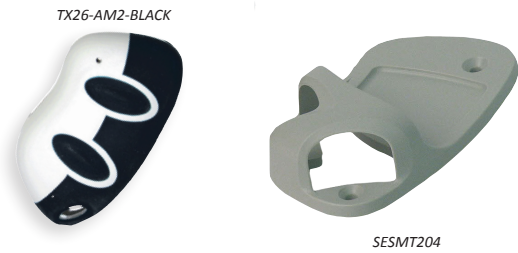

*We can offer our hand-held transmitters with the option of an integral proximity tag  
Please contact our sales office for details.*



**TRANSMITTERS**

**TX SERIES**

Wall mount transmitters



TX26-TM  
80 x 80 x 25mm



TSW2641E1  
82 x 67 x 66mm

- Rolling code
- Internal wall mount transmitter
- External wall mount transmitter
- Keypad transmitter
- Touch-sensitive transmitter
- Infrared transmitter
- Adaptable transmitter
- Ideal for wire-free applications
- Up to 200m range

- Frequency: 433.92MHz
- Modulation: AS
- Range: 100-200M in open space
- Encoding: Keeloq® Hopping code



GALEOR  
110 x 75 x 15mm



SENSRAD  
90 x 60 x 25mm



SENSIR  
90 x 60 x 25mm

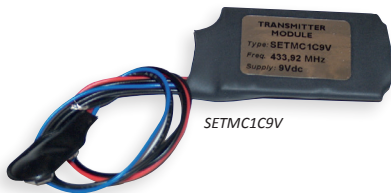

SETMC1C9V

Adaptable transmitter can be fitted into a variety of switching devices



NANO Receiver



**RECEIVERS**
**RX SERIES**
**Internal receivers**

SEL2641R433NN (NANO)  
50 x 32 x 20mm

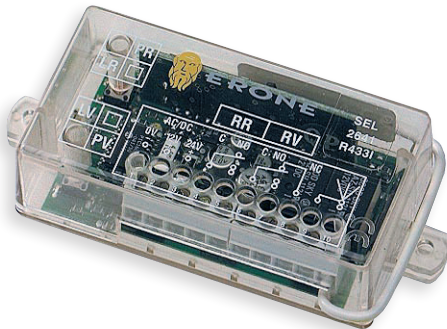

RX26-433I/RX39-433  
105 x 45 x 28mm

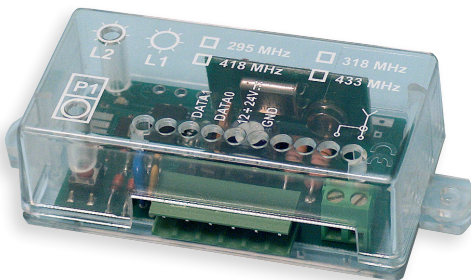

SELWR433  
105 x 45 x 28mm

- 1 & 2 channel receivers
- Rolling code & fixed code option
- Timed and pulse operation
- Wiegand receiver option
- Easy learn of transmitters
- 12-24V ac/dc
- Extension tuned aerial (SEA433)

- Frequency: 433.92MHz
- Keeloq® Hopping code
- Fixed code (RX39)
- Modulation: AS
- Range: 100-200m in open space
- Memory:
  - 85 transmitters (SEL2641R433NN & RX26-433I)
  - Unlimited transmitters (SELWR433)
  - 100 transmitters (RX39-433)

- Dimensions:
  - 50 x 32 x 20mm (SEL2641R433NN)
  - 105 x 45 x 28mm (RX26-433I & RX39-433I)
  - 105 x 45 x 28mm (SELWR433)

Please contact the sales office for fixed code options

## RECEIVERS

### RX SERIES

### External receivers

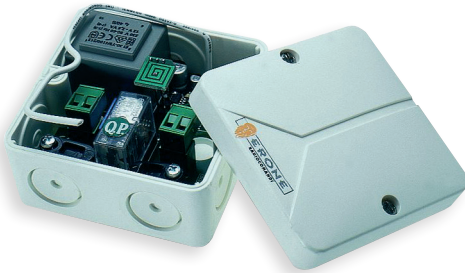

RX26-Z1



RX26-433-C4V



SEA433

- **External rated receivers.**
- **1, 2 & 4 channel.**
- **12-24V ac/dc option.**
- **240V ac option.**
- **Rolling code units.**
- **Extension tuned aerial (SEA433).**

- Frequency: 433.92MHz
- Encoding: Keeloq<sup>®</sup> Hopping code
- Modulation: AS
- Range: 100-200m in open space
- Memory: 85 transmitters

- Dimensions:
  - 80 x 80 x 50mm (RX26-Z1, Z2 & Z4)
  - 140 x 115 x 53mm (RX26-433-C2V & C4V)

- SEA433:
  - RG58 cable
  - 50 Ohm characteristic impedance
  - 3.5M length

**METAL FABRICATION**
**READER/INTERCOM POSTS** High quality metal fabricatio

**A range of posts to compliment and optimise any access control or automation project. With an understanding that aesthetics and practicality are equally important, these products are suitable to fit in any environment.**

Where aesthetics are important, the stainless steel range includes models to cater for car, wheelchair and pedestrian users. This range is manufactured from high grade stainless steel and has a polished and hardened grain finish. The RPSS-CUT includes a 60 x 45mm hole with M3.5 tapped holes to accept standard UK plates to fit exit buttons, key switches, readers etc.

Where practicality is more important than aesthetics, the GNP range is made from steel with a black, hardened powder-coat finish. These are ideal for car and lorry parks.

For dimensional drawings, please contact your local distributor or call CDVI.





Any speed, color, or within this document (photos, drawings, features and dimensions) may be changed without prior notice.

**IQ Trading**  
Киев, 04080, Украина  
87-А, ул.Межигорская  
web: [www.iqtrading.com.ua](http://www.iqtrading.com.ua)

Phone: Тел: +380 (44) 351 14 37  
Email: [disti@iqtrading.com.ua](mailto:disti@iqtrading.com.ua)

**CDVI Ltd**  
Unit B1, Knaves Beech Business Centre,  
Davies Way, Loudwater,  
High Wycombe, Bucks, HP10 9QR

Phone: 01628 531300  
Email: [support@cdvi.co.uk](mailto:support@cdvi.co.uk)

